

alu-druckguss



FIRMENPRÄSENTATION

Stand Januar 2010

J. Krüger

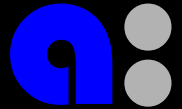

- Mittelständischer Automobilzulieferer
- Umsatz 2008 nahe 40 Mio. €
- Nr. 8 in Deutschland
- > 5.000 t Aluminium, 7 Mio. Teile pro Jahr
- Gießen, Zerspanen und Montieren
- 375 Mitarbeiter in Deutschland und Polen

Struktur



Drei selbständige Firmen

Inhabergeführtes Familienunternehmen

Minderheitsgesellschafter: IKB Equity Finance

alu-druckguß Berlin
Berlin-Reinickendorf

75 Mitarbeiter

Geschäftsführer
Guenter Goldhammer

alu-druckguss Brandenburg
Brieselang

250 Mitarbeiter

Geschäftsführer
Jochen Krüger

alu-druckguss Polen
Nowa Sol/Kozuchow

50 Mitarbeiter

Geschäftsführer
Jochen Krüger

alu-druckguß Berlin



- Gegründet 1983
- Vorläufer Maschinenbau Ludwig Loewe, erster Druckguss in Europa (1906)
- 13 Druckgussmaschinen
400 – 1100 t Schließkraft
- 75 Mitarbeiter



alu-druckguss Brandenburg

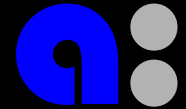

- Gegründet 1991
- 9 Druckgussmaschinen
660 –1200 t Schließkraft
- Zerspanung
 - 20 CNC-Bearbeitungszentren
 - Drehautomaten
 - Sondermaschinen
- 250 Mitarbeiter

alu-druckguss Polen



- Gegründet 2001
- 3 Std. von Berlin
- Montage und Bearbeitung
- 50 Mitarbeiter



Kompetenz Gießen



- Hochkomplexe Gussteile
- Gießzellenfertigung
- Vakuumverfahren
- SC-Technik, Squeezen
- Bedampfung von Formen

Zertifizierungen

- ISO TS 16949 : 2002
- DIN EN ISO 9001 : 2002



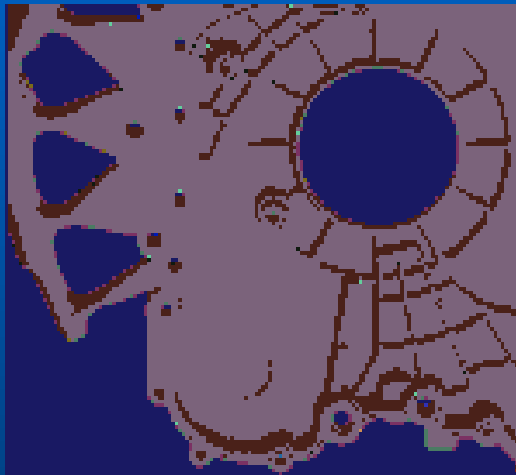

- Anfertigung von Prototypen
(Rapid Tooling, Sandguss-Muster)
- CAD-Datenanpassung mit Pro/ENGINEER
- Gießprozess-Simulation
- Entwicklungskooperation
Schlote-Gruppe
(Bearbeitung und Formenbau)
- Mitarbeit im Arbeitskreis Druckguss
(Uni Braunschweig)

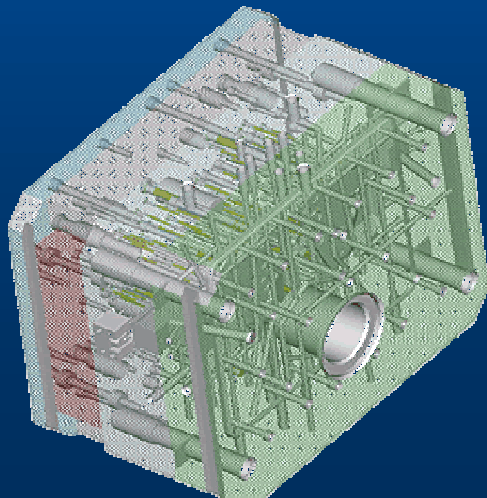

Kompetenz Bearbeitung

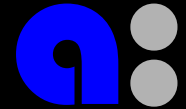

- Komplexe, effiziente Bearbeitung
- Teilmontage
- Zusatzleistungen
 - Druckprüfen
 - Imprägnieren
 - Entfetten
 - Veredeln
 - Beschichten



Produkte: Motor

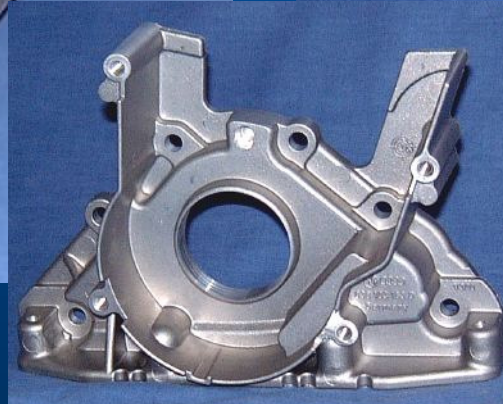
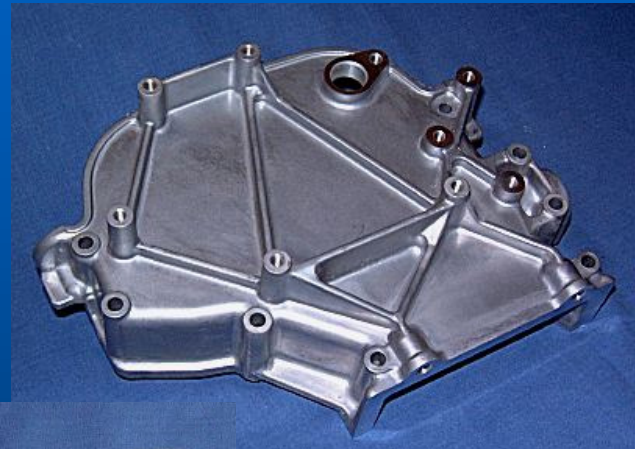
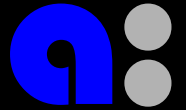

Produkte: Lenkung, Getriebe

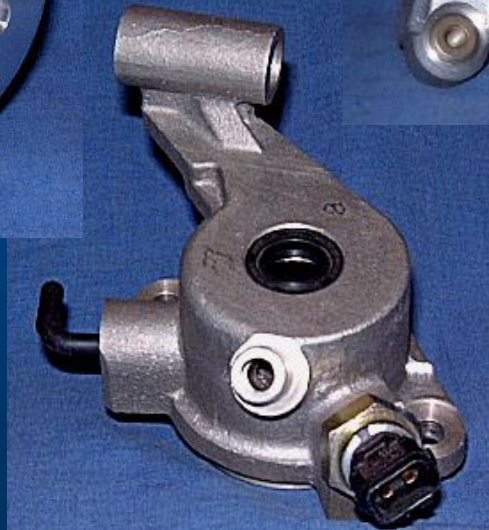

Produkte: Pumpen, Filter

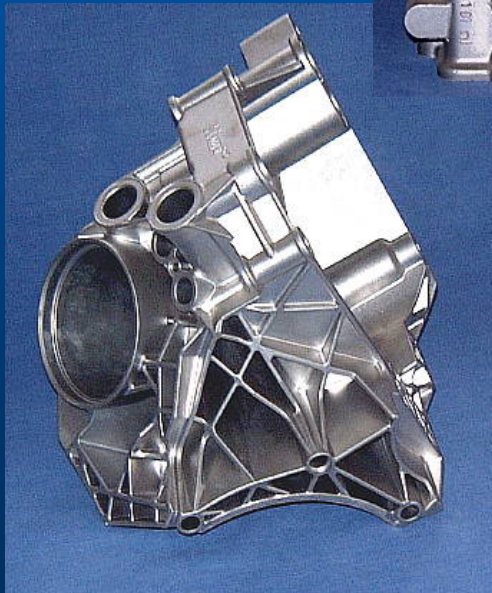
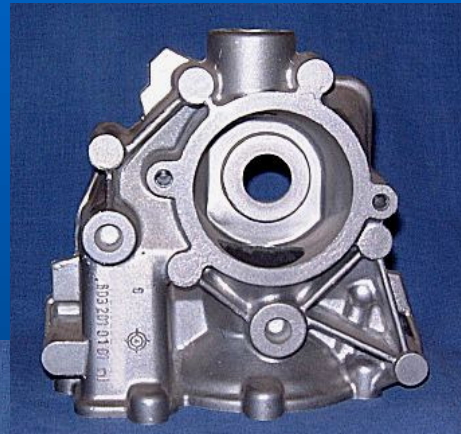
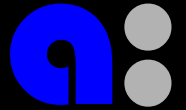

Referenzen

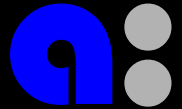

Vielen Dank für Ihre Aufmerksamkeit !

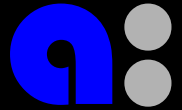

alu-druckguss

Technologie trifft Zuverlässigkeit

krueger@alu-druckguss.de
Tel. +49 33232-2000